

eldes

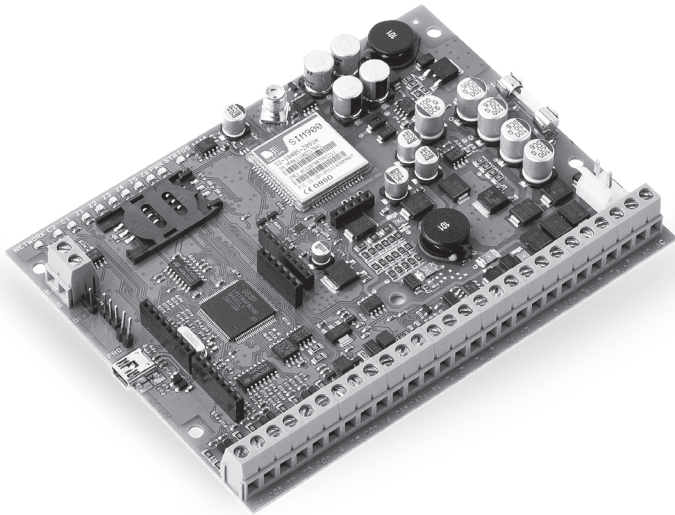

GSM ALARM AND MANAGEMENT SYSTEM

USER MANUAL **ESIM264**

COMPLIES WITH EN 50131-1 GRADE 2, CLASS II REQUIREMENTS

User Manual v2.1

Valid for ESIM264 v7.11.18 and up

Safety instructions

Please read and follow these safety guidelines in order to maintain safety of operators and people around:

- GSM alarm & management system ESIM264 (also referenced as alarm system, system or device) has radio transceiver operating in GSM 850/900/1800/1900 bands.
- DO NOT use the system where it can be interfere with other devices and cause any potential danger.
- DO NOT use the system with medical devices.
- DO NOT use the system in hazardous environment.
- DO NOT expose the system to high humidity, chemical environment or mechanical impacts.
- DO NOT attempt to personally repair the system.
- System label is on the bottom side of the device.



GSM alarm system ESIM264 is a device mounted in limited access areas. Any system repairs must be done only by qualified, safety aware personnel.



The system must be powered by main 16-24V 50 Hz ~1.5A max or 18-24V --- 1,5A max DC power supply which must be approved by LST EN 60950-1 standard and be easily accessible nearby the device. When connecting the power supply to the system, switching the pole terminals places does not have any affect.



Any additional devices linked to the system ESIM264 (computer, sensors, relays etc.) must be approved by LST EN 60950-1 standard.



Main power supply can be connected to AC mains only inside installation room with automatic 2-pole circuit breaker capable of disconnecting circuit in the event of short circuit or over-current condition. Open circuit breaker must have a gap between connections of more than 3mm and the disconnection current 5A.

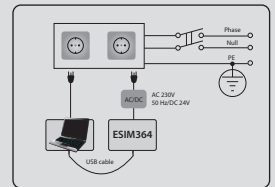

Mains power and backup battery must be disconnected before any installation or tuning work starts. The system installation or maintenance must not be done during stormy conditions.



Backup battery must be connected via the connection which in the case of breaking would result in disconnection of one of battery pole terminals. Special care must be taken when connecting positive and negative battery terminals. Switching the pole terminals places is NOT allowed.



In order to avoid fire or explosion hazards the system must be used only with approved backup battery.



The device is fully turned off by disconnecting 2-pole switch off device of the main power supply and disconnecting backup battery connector.



Fuse F1 type – Slow Blown 3A. Replacement fuses have to be exactly the same as indicated by the manufacturer.



If you use I security class computer for setting the parameters it must be connected to earth.



The WEEE (Waste Electrical and Electronic Equipment) marking on this product (see left) or its documentation indicates that the product must not be disposed of together with household waste. To prevent possible harm to human health and/or the environment, the product must be disposed on in an approved and environmentally safe recycling process. For further information on how to dispose of this product correctly, contact the system supplier, or the local authority responsible for waste disposal in your area.

Limited Liability

The buyer must agree that the system will reduce the risk of fire, theft, burglary or other dangers but does not guarantee against such events.

“ELDES UAB” will not take any responsibility regarding personal or property or revenue loss while using the system. “ELDES UAB” liability according to local laws does not exceed value of the purchased system. “ELDES UAB” is not affiliated with any of the cellular providers therefore is not responsible for the quality of cellular service.

Manufacturer Warranty

The system carries a 24-month warranty by the manufacturer “ELDES UAB”. Warranty period starts from the day the system has been purchased by the end user. The warranty is valid only if the system has been used as intended, following all guidelines listed in the manual and within specified operating conditions. Receipt must be kept as a proof of purchase date.

The warranty is voided if the system has been exposed to mechanical impact, chemicals, high humidity, fluids, corrosive and hazardous environments or other force majeure factors.

Technical Support

If you require more detailed information on your system or in case of system failure occurrence, please, contact your alarm system installer.

About User Manual

This document describes basic configuration and usage of alarm system ESIM264. It is very important to read the user manual before starting to use the system.

Package Content

1. ESIM264 qty. 1
2. Microphone..... qty. 1
3. SMA antenna qty. 1
4. Backup battery connection wire qty. 1
5. User manual qty. 1
6. Resistor 5,6kΩ..... qty. 6
7. Resistor 3,3kΩ..... qty. 6

NOTE: For full system configuration and control, please refer to ESIM264 installation manual located at www.eldes.lt/en/download

Contents

1. General Information.....	4
1.1 Short Description of Main Definitions.....	4
1.2 EKB2 Keyboard Overview.....	5
1.3 EKB3 Keyboard Overview.....	7
1.4 Partitions	7
2. Technical Specifications	8
2.1 Electrical & Mechanical Characteristics.....	8
2.2 Main Unit, LED & Connector Functionality	9
2.3 Wiring Diagrams.....	10
2.3.1 General Wiring	10
2.3.2 Zone Connection Types.....	10
3. Basic Configuration & Use.....	11
3.1 Setting Up Date & Time.....	11
3.2 Arming, Disarming the System & Turning Off the Alarm.....	12
3.2.1 Arm, Disarm & Turn off the Alarm by Phone Call.....	12
3.2.2 Arm by SMS Message	13
3.2.3 Disarm & Turn off the Alarm by SMS Message	13
3.2.4 Arm by EKB2/EKB3 Keyboard	14
3.2.5 Disarm & Turn off the Alarm by EKB2/EKB3 Keyboard.....	14
3.2.6 Arm by iButton® Key	15
3.2.7 Disarm & Turn off the Alarm by iButton® Key	15
3.2.8 Arm by EWK1 – Wireless Key-fob.....	16
3.2.9 Disarm & Turn off the Alarm by EWK1 – Wireless Key-fob.....	16
3.3 Activating STAY Mode	17
3.3.1 Arm by EKB2 Keyboard in STAY Mode Manually	17
3.4 Alarm Indications & Viewing Violated Zones / Tamper.....	19
3.5 Bypassing & Unbypassing Violated Zone.....	20
3.6 Viewing System Information	21
3.7 Managing Periodical System Information.....	21
3.8 Viewing Zone & PGM Output Information.....	22
3.9 Managing Temperature Information	23
3.10 Trouble Indications.....	24
3.11 Controlling Electrical Appliances	25
3.12 Turning ON/OFF the Electrical Appliances for a Determined Time Period	26
4. If the Alarm System is Connected to Monitoring Station.....	27

1. General Information

ESIM264 is an alarm system for private houses, cottages, village houses, garages, warehouses and other buildings, also capable of turning on/off the electrical appliances by SMS message and alarm system keyboard. This alarm system provides a simple thus effective way of use.

The system consists of:

- ESIM264 alarm system device;
- Up to 4 EKB2/EKB3 keyboards;
- Wired and/or wireless sensors: movement sensors, magnetic door sensors, smoke sensors etc.;
- Other devices: indoor/outdoor sirens, heating, lighting, gates etc.

For more details on ESIM264 system, please, consult with your alarm system installer.

1.1 Short Description of Main Definitions

The following table provides the explanation of main definitions which are met in this user manual.

Definition	Description
System; alarm system	ESIM264 device
SMS	Short Message Service text
Keyboard	Device with a set keys allowing to configure & control the system, view violated zones & system troubles
EKB2	Model of LCD keyboard
EKB3	Model of LED keyboard
User phone number; <i>User 1... 5</i>	Phone number of the user allowed to control the system
System phone number	Phone number of the SIM card inserted in ESIM264 device
User password	4-digit combination intended for system arming/disarming using a keyboard
iButton® key	Small metal tab containing a unique ID code intended for system arming/disarming
Zone	Alarm system input for wired and wireless sensor connection
PGM output	Alarm system output for connection of electrical appliances (heating, lighting, gates etc.)
Partition	Section dividing one alarm system into two independent parts software-wise

1.2 EKB2 Keyboard Overview

EKB2 is an LCD keyboard intended for using with ESIM264 alarm system.

Keys Functionality

	One menu level back / cancel
	Menu navigation – up
	Menu navigation – down
OK	Confirm (enter) value
0 ... 9	Value typing
P1	Keyboard partition switch / minus symbol for entering negative temp. value
P2	Additional menu / minus symbol for entering negative temp. value

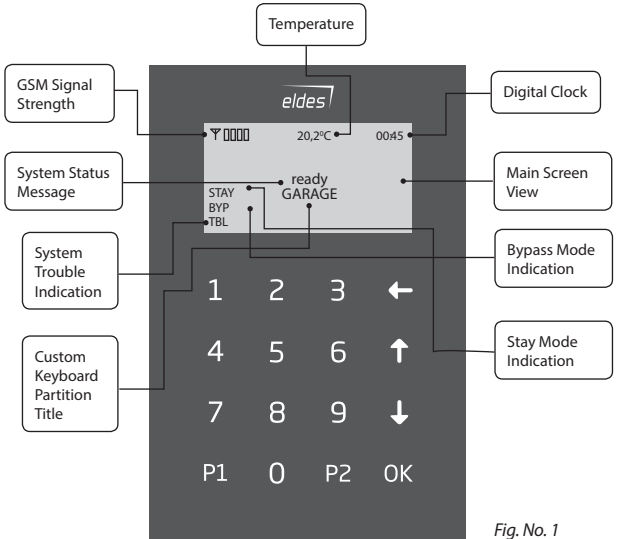

Fig. No. 1

Main Messages & Icons

Icon / Message	Description
	Delay zone violated when system is disarmed.
	Exit Delay countdown initiated.
	System is armed and menu is locked.
	System is disarmed and menu is unlocked
	Configuration mode activated.
+ CONFIGURATION MODE	
BURGLARY ALARM	Delay, Instant or Follow zone violated when system is armed.

Icon / Message	Description
24 ALARM	24H zone violated.
FIRE ALARM	Fire zone violated.
TAMPER ALARM	Tamper violated
READY	System is ready to be armed.
NOT READY	System is not ready to be armed – one or more zones / tampers violated.
ARMED	System is armed (optional feature).
STAY	Stay mode activated
BYP	One or more zones bypassed
TBL	One or more system troubles are present

EKB2 LCD screen is intended for displaying alarm system status messages and alerts. Message **READY** is displayed on the screen that no zones are violated or no troubles are present and the system is prepared for arming. Message **NOT READY** (and **TBL**) shows up in case of zone violation or if system troubles are present. The alarm system cannot be armed until the troubles are removed or violated zone (-s) is restored, bypassed or set up to operate under *Force* mode. The following troubles allow system arming when present:

- backup battery problem;
- main power supply failure;
- date & time not set;
- GSM connection problem.

Audio Indication

The built-in mini buzzer uses two types of sound signals – three short beeps and one long beep. Three short beeps stand for successfully carried out configuration, one long beep – for invalid configuration. In addition, the mini-buzzer continuously provides short beeps in case of alarm.

Visual Indication

EKB2 can be used even in dark premises as the LCD screen and keys are illuminated continuously. In case of alarm the keyboard illumination level is boosted and stays in this state until the system is disarmed. The illumination level lowers down in 3 minutes after the last key-touch while the system is disarmed.

1.3 EKB3 Keyboard Overview

EKB3 is a LED keyboard intended for using with ESIM264 alarm system.

LED Functionality

ARMED	Alarm system is armed /Configuration mode
READY	System is prepared for arming
SYSTEM	System troubles / valid command is being entered
BYP5	Zone bypass mode
1-12	Violated zone

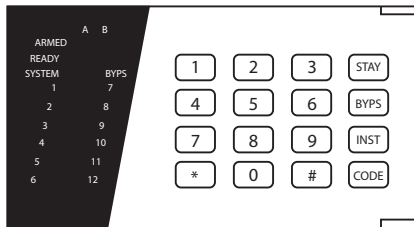

Fig. No. 2

Keys Functionality

[BYP5]	Zone bypass mode
[CODE]	Additional options - system trouble list / violated high zone indication / violated tamper indication
[*]	Configuration mode (when typed as a 1st character) / cancel command (when typed as a 2nd character) / keyboard partition switch (if enabled)
[#]	Confirm (enter) command
[0] ... [9]	Command typing
[STAY]	Manual Stay mode activation
[INST]	(currently inactive)

The green LED **READY** indicates that no zones are violated or no troubles are present and the system is prepared for arming. LED **SYSTEM** lights up or flashes in case of zone violation or if system troubles are present. The alarm system cannot be armed until the troubles are removed or violated zone (-s) is restored, bypassed or set up to operate under *Force* mode. The following troubles allow system arming when present:

- backup battery problem;
- main power supply failure;
- date & time not set;
- GSM connection problem.

Audio Indication

The built-in mini buzzer uses two types of sound signals – three short beeps and one long beep. Three short beeps stand for successfully carried out configuration command, one long beep – for invalid configuration command. In addition, the mini-buzzer continuously provides short beeps in case of alarm.

Visual Indication

EKB3 keys have a LED back-light, therefore it is possible to use this keyboard even in dark premises. In case of alarm the keyboard back-light turns on and lasts until the system is disarmed. The back-light lasts for 3 minutes after the last key-stroke while the system is disarmed.

1.4 Partitions

Your alarm system may be divided into 2 partitions: *partition 0* & *partition 1*. Each system partition operates independently from each other, therefore dividing the system into partitions allows to use 1 alarm system unit to secure 2 different areas, for example: office and warehouse, house and garage. By default configuration, the system is NOT divided into 2 partitions and all user phone numbers, user passwords, keyboards, iButton® keys, zones are assigned to *partition 0*.

2. Technical Specifications

2.1 Electrical & Mechanical Characteristics

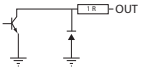
Electrical & Mechanical Characteristics	
Main Power Supply	16-24V 50 Hz ~1.5A max / 18-24V $\overline{\text{---}}$ 1,5A max
Current in Standby without External Sensors and Keyboard	Up to 80mA
Recommended Backup Battery Voltage, Capacity	12V; 1,3-7Ah
Recommended Backup Battery Type	Lead-Acid
Maximum Battery Charge Current	900mA
GSM Modem Frequency	850/900/1800/1900MHz
Cable Type for GSM/GPRS Antenna Connection	Shielded
Number of Zones on Board	6 (ATZ mode: 12)
Nominal Zone Resistance	5,6k Ω (ATZ Mode: 5,6k Ω and 3,3k Ω)
Number of PGM Outputs on Board	4
PGM Output C1-C4 Circuit	 <p>Open Collector Output. Output is pulled to COM when turned ON.</p>
Maximum Commuting PGM Output Values	Voltage – 30V; Current – 100mA;
BELL: Siren Output when Activated	Connected to COM
BELL: Maximum Siren Output Current	500mA
BELL: Maximum Cable Length for Siren Connection	up to 30 meters
BELL: Cable Type for Siren Connection	Unshielded
AUX: Auxiliary Equipment Power Supply Voltage	13,8V DC
AUX/BELL: Maximum Accumulative Current of Auxiliary Equipment and Siren	1A
AUX: Maximum Cable Length for Auxiliary Equipment Connection	up to 100 meters
AUX: Cable Type for Auxiliary Equipment Connection	Unshielded
BUZ: Maximum Current of Mini Buzzer	150mA
BUZ: Power Supply Voltage of Mini Buzzer	5V DC
BUZ: Cable Type for Mini Buzzer Connection	Unshielded
Dimensions	140x100x18mm
Operating Temperature Range	-20...+55°C
Supported Temperature Sensor Model	Maxim [®] /Dallas [®] DS18S20, DS18B20
DATA: Maximum Cable Length for 1-Wire [®] Communication	up to 30 meters
DATA: Cable Type for 1-Wire [®] Communication	Unshielded
Supported iButton [®] Key Model	Maxim [®] /Dallas [®] DS1990A
Maximum Supported Number of Keyboards	4 x EKB2 / EKB3
Y/G: Maximum Cable Length for RS485 Communication	up to 100 meters
Y/G: Cable Type for RS485 Communication	Unshielded
MIC: Maximum Cable Length for Microphone Connection	Up to 2 meters
MIC: Cable Type for Microphone Connection	Unshielded
Wireless Transmitter-Receiver Frequency *	868 Mhz
Wireless Communication Range*	Up to 30m in premises; up to 150m in open areas
Maximum Supported Number of Wireless Devices*	16
Event Log Size	500 events
Maximum Supported Number of Zones	44
Maximum Supported Number of PGM Outputs	44
Cable Type for Zone and PGM Output Connection	Unshielded
Communications	SMS, Voice calls. GPRS network, RS485, CSD
Supported Protocols	Ademco Contact ID [®] , 4+2, EGR100, Kronos

* only for system ESIM264 with module EWT1

2.2 Main Unit, LED & Connector Functionality

Main Unit Functionality	
GSM MODEM	GSM network 850/900/1800/1900MHz modem
SIM CARD	SIM card slot / holder
DEF	Pins for restoring default settings
USB	Mini USB port
FUSE F1	3A fuse
ANTENNA	GSM/GPRS antenna SMA type connector
MODULES	Slots for EA1, EA2 or EPGM8 module
EWT1	Slots for EWT1 wireless module

LED Functionality	
NETWORK	GSM network signal strength
C2, C1	PGM output C1, C2 status – on/off
Z1	Zone Z1 state – alarm/restore (ATZ mode: Z1 and Z7)
Z2	Zone Z2 state – alarm/restore (ATZ mode: Z2 and Z8)
Z3	Zone Z3 state – alarm/restore (ATZ mode: Z3 and Z9)
Z4	Zone Z4 state – alarm/restore (ATZ mode: Z4 and Z10)
Z5	Zone Z5 state – alarm/restore (ATZ mode: Z5 and Z11)
Z6	Zone Z6 state – alarm/restore (ATZ mode: Z6 and Z12)
PWR	Power supply status
STATUS	Micro-controller status

Connector Functionality	
Z1 - Z6	Security zones
COM	Common terminal for all zones
DATA	1-Wire® interface for iButton® key & temperature sensor connection
+5V	Temperature sensor power supply contact (+5V)
MIC-	Microphone negative terminal
MIC+	Microphone positive terminal
BUZ-	Mini buzzer negative terminal
BUZ+	Mini buzzer positive terminal
C1 - C4	PGM outputs
Y	RS485 interface for communication (yellow wire)
G	RS485 interface for communication (green wire)
COM	Common return terminal
BELL-	Siren negative terminal
BELL+	Siren positive terminal
AUX-	Negative power supply terminal for auxiliary equipment
AUX+	Positive power supply terminal for auxiliary equipment
AC/DC	Main power supply terminal
AKU-	Backup battery negative terminal
AKU+	Backup battery positive terminal

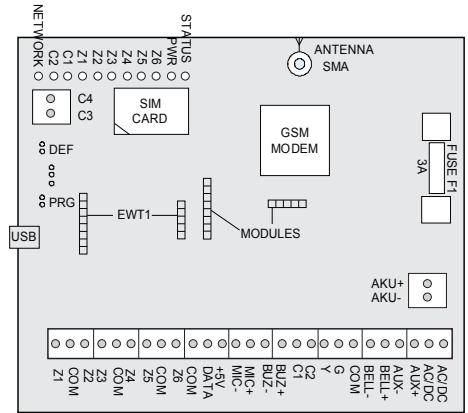
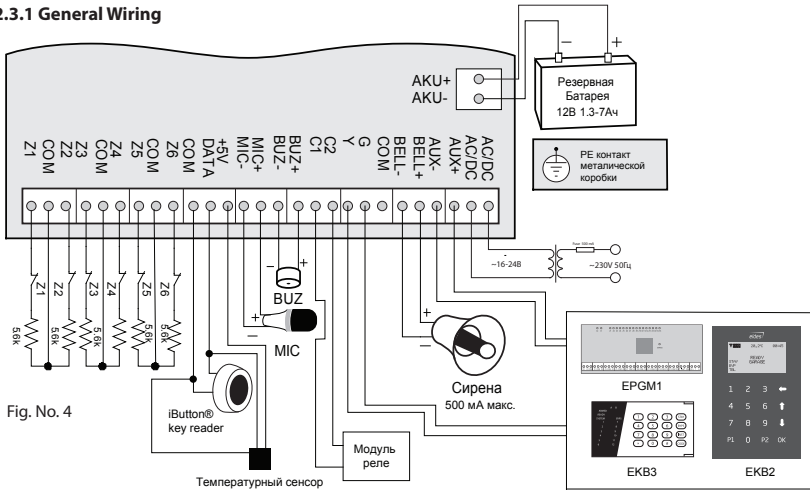

Fig. No.3

2.3 Wiring Diagrams

2.3.1 General Wiring



2.3.2 Zone Connection Types

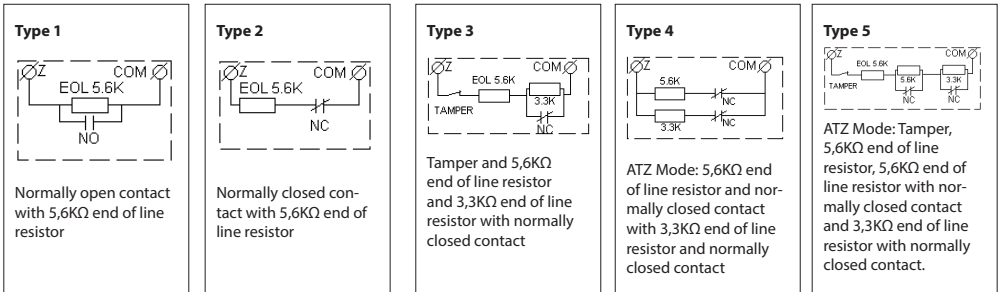

Fig. No. 5

3. Basic Configuration & Use

ATTENTION: System configuration described in this chapter is based on default system parameter values. Your alarm system installer may have changed those values. For more details, please, contact your alarm system installer.

This chapter provides a description of basic configuration and use of ESIM264 alarm system by the following methods:

- SMS message;
- Phone call;
- EKB2 keyboard;
- EKB3 keyboard;
- iButton® key.

SMS

In order to configure and control the system using SMS message, send the text command to the ESIM264 system phone number from one of the preset user phone numbers. In this user manual the underscore symbol “_” represents one space character. Every underscore symbol must be replaced by a single space character. There must be no spaces or other unnecessary characters at the beginning and at the end of the message. **XXXX** – 4-digit SMS password set by your alarm system installer.

EKB2

The system configuration and control by EKB2 keyboard is performed by navigating throughout the menu section list displayed on LCD screen. To navigate in the menu path, touch ↓, ↑ keys to select the desired menu section and touch *OK* key to open the selected section. To enter a required value, use 0... 9 keys and touch *OK* key for value confirmation or cancel/go one menu section back by touching ←-key. The value can be typed in directly by touching 0... 9 keys while highlighting the desired menu section. EKB2 menu type is “circle”, therefore when the last section in the menu list is selected, you will be brought back to the beginning of the list after touching the ↓ key. In this user manual, the menu path is provided under “tree” view by starting at main screen view. In this user manual valid parameter values and range are indicated in brackets.

EKB3

The system configuration and control by EKB3 keyboard is performed by entering a valid configuration command using the number keys 0... 9 and [#] key for confirmation. Some commands require [BYP], [CODE] and [STAY] keys as well. The structure of standard configuration command is a combination of digits. In this user manual configuration commands, valid parameter values and range are indicated in brackets.

3.1 Setting Up Date & Time

NOTE: When the alarm system is connected to a monitoring station the date and time are set automatically. The system retrieves this data from the monitoring station by itself.

SMS

1. Send the following SMS message to the phone number of ESIM264 alarm system:

SMS text:

XXXX_YYYY.MM.DD_HR:MN

Value: YYYY– year; MM – month, range – [01... 12]; DD – day, range - [01... 31];

HR – hours, range – [00... 23], MN – minutes, range – [00... 59];

Example: 1111_2011.12.15_13:45

2. The system will reply with confirmation by SMS message to user phone number who sent the SMS message after the date & time is set successfully.

EKB2

Navigate through the following menu path using *OK* and arrow keys and enter the date and time values using the number keys:

Menu path:

OK → DATE/TIME SET → [YYYY-MM-DD_HR:MN]

Value: YYYY– year; MM – month, range – [01... 12]; DD – day, range - [01... 31];

HR – hours, range – [00... 23], MN – minutes, range – [00... 59];

Example: 2011-12-15 13:45

3.2. Arming, Disarming the System & Turning Off the Alarm

Before arming the system it is necessary to close all doors and windows in the secured area and move yourself away from the movement detection field.



Fig. No. 6

3.2.1 Arm, Disarm & Turn off the Alarm by Phone Call

ATTENTION: User must leave the secured area before arming the system by phone call.



1. To arm the system, disarm the system or turn off the alarm, make a phone call to the system's phone number from any out of 5 preset user phone numbers. The phone call is free charge as the system rejects it and performs arming or disarming after-wards. When arming the system, it rejects the phone call after 2 rings, when disarming - the system rejects the phone call immediately.
2. After the system is successfully armed or disarmed, it will reply with confirmation by SMS message to the user phone number who made a phone call.



Fig. No. 7

3. When attempting to arm the system in case of violated zone / tamper presence, the system will reply with violated zone / tamper number. For more details, please refer to chapter **2.5 Bypassing & Unbypassing Violated Zone**.

3.2.2 Arm by SMS Message

SMS

1. Leave the secured area.
2. To arm the system, send the following SMS message to the system's phone number from any out of 5 preset user phone numbers:

SMS text:

`XXXX_ARM1` or `XXXX_ARM2` or `XXXX_ARM1,2`

Value: 1 – partition 0; 2 – partition 1; 1,2 – both partitions

Example: `1111_ARM1`

3. After the system is successfully armed, it will reply with confirmation by SMS message to the user phone number who sent the SMS message.

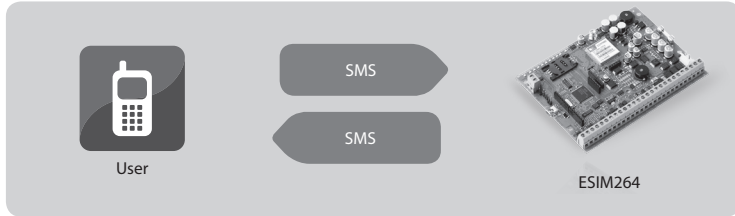

Fig. No. 8

4. When attempting to arm the system in case of violated zone / tamper presence, the system will reply with violated zone / tamper number. For more details, please refer to chapter **2.5 Bypassing & Unbypassing Violated Zone**.

3.2.3 Disarm & Turn off the Alarm by SMS Message

SMS

1. The system will initiate the *Entry Delay* countdown (by default – 15 seconds) after the user has entered the secured area. *Entry Delay* countdown is intended for user to enter a valid user password before the alarm is caused.
2. To disarm the system or turn off the alarm, send the following SMS message to the system's phone number from any out of 5 preset user phone numbers:

SMS text:

`XXXX_DISARM1` or `XXXX_DISARM2` or `XXXX_DISARM1,2`

Value: 1 – partition 0; 2 – partition 1; 1,2 – both partitions

Example: `1111_DISARM1`

3. After the system is successfully disarmed, it will reply with confirmation by SMS message to the user phone number who sent the SMS message.

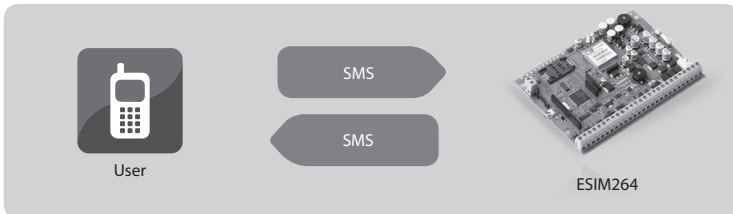

Fig. No. 9

3.2.4 Arm by EKB2/EKB3 Keyboard



1. To arm the system, enter any out of 10 available 4-digit user passwords using the number keys:

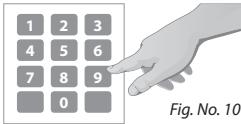

Fig. No. 10

Enter user password:

[NNNN]

Value: NNNN – 4-digit user password

EKB2 Example: 1111OK

EKB3 Example: 1111

2. The system will initiate the *Exit Delay* countdown (by default – 15 seconds) intended for user to leave the secured area. The countdown is indicated by short beeps provided by keyboard built-in mini-buzzer (if any).
3. After the system is successfully armed, it will reply with confirmation by SMS message to *User 1* phone number (by default).



Fig. No. 11

3.2.5 Disarm & Turn off the Alarm by EKB2/EKB3 Keyboard



1. The system will initiate the *Entry Delay* countdown (by default – 15 seconds) after the user has entered the secured area. *Entry Delay* countdown is intended for user to enter a valid user password before the alarm is caused.
2. To disarm the system or turn off the alarm, enter any out of 10 available 4-digit user passwords using the number keys:

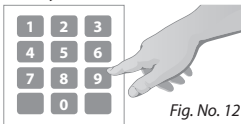

Fig. No. 12

Enter user password:

[NNNN]

Value: NNNN – 4-digit user password

EKB2 Example: 1111OK

EKB3 Example: 1111

3. After the system is successfully disarmed, it will reply with confirmation by SMS message to *User 1* phone number (by default).



Fig. No. 13

3.2.6 Arm by iButton® Key



1. To arm the system, touch the iButton® key reader by any out of 5 iButton® keys:

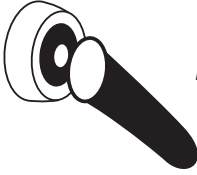

Fig. No. 14

2. The system will initiate the *Exit Delay* countdown (by default – 15 seconds) intended for user to leave the secured area. The countdown is indicated by short beeps provided by ESIM264 mini-buzzer (if any).
3. After the system is successfully armed, it will reply with confirmation by SMS message to *User 1* phone number (by default).



Fig. No. 15

3.2.7 Disarm & Turn off the Alarm by iButton® Key



1. The system will initiate the *Entry Delay* countdown (by default – 15 seconds) after the user has entered the secured area. *Entry Delay* countdown is intended for user to enter a valid user password before the alarm is caused.
2. To disarm the system or turn off the alarm, touch the iButton® key reader by any out of 5 iButton® keys:

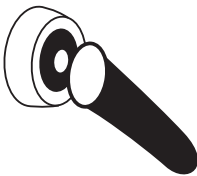

Fig. No. 16

3. After the system is successfully disarmed, it will reply with confirmation by SMS message to *User 1* phone number (by default).



Fig. No. 17

3.2.8 Arm by EWK1 – Wireless Key-fob



1. To arm the system, press 1 out of 4 EWK1 buttons (by default –  button) assigned to arm the alarm system.

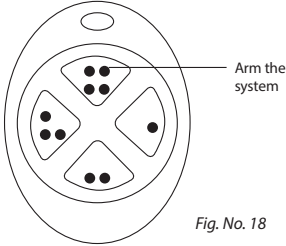

Fig. No. 18

2. The system will initiate the *Exit Delay* countdown (by default – 15 seconds) intended for user to leave the secured area.
3. After the system is successfully armed, it will reply with confirmation by SMS message to *User 1* phone number (by default).



Fig. No. 19

3.2.9 Disarm & Turn off the Alarm by EWK1 – Wireless Key-fob



1. The system will initiate the *Entry Delay* countdown (by default – 15 seconds) after the user has entered the secured area. *Entry Delay* countdown is intended for user to enter a valid user password before the alarm is caused.
2. To disarm the system or turn off the alarm, press 1 out of 4 EWK1 buttons (by default –  button) assigned to disarm the alarm system

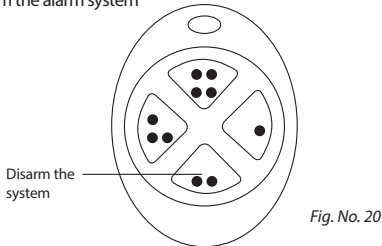

Fig. No. 20

3. After the system is successfully disarmed, it will reply with confirmation by SMS message to *User 1* phone number (by default).



Fig. No. 21

3.3 Activating STAY Mode

EKB2

EKB3



EWK1

Stay mode allows the user to remain in the secured area after arming the system. In *Stay* mode, the system does not cause the alarm when the zones, set up to operate under this mode, become violated. This mode is usually used when arming the system before night.

There are two ways to activate *Stay* mode:

- **Automatic** - This mode is activated automatically in case the user does not leave the secured area (if *Delay* zone is not violated) during *Exit Delay* countdown when arming the system.
- **Manual** - The system goes into *Stay* mode after the user opens an additional menu or presses [STAY] key and enters a valid user password by EKB2/EKB3 keyboard.

There is no *Exit Delay* countdown when activating *Stay* mode manually.

Stay mode status is indicated in the main screen view of EKB2.

Stay mode is NOT activated when arming the system by phone call or SMS message.

NOTE: *Delay Zone Becomes Instant in Stay Mode* feature may be enabled on your system. In that case the alarm will be caused instantly instead of *Entry Delay* countdown being initiated if a *Delay* zone becomes violated while the system is operating in *Stay* mode. For more details, please, contact your alarm system installer.

3.3.1 Arm by EKB2 Keyboard in STAY Mode Manually

EKB2

1. Navigate through the following menu path using P2 and arrow keys and enter a valid user password using the number keys to arm the system in *Stay* mode manually:

Menu path:

P2 → ENTER STAY → [NNNN] → OK

Value: [NNNN] - 4-digit user password

2. After the system is successfully armed, it will reply with confirmation by SMS message to User 1 phone number (by default).



For more details on how to disarm & turn off the alarm by EKB2 keyboard, please refer to chapter **3.2.5 Disarm & Turn off the Alarm by EKB2/EKB3 Keyboard**

3.3.2 Arm by EKB3 Keyboard in STAY Mode Manually



1. Arm the system in *Stay* mode manually by entering the following combination using [STAY] and number keys:
Press [STAY] key & enter user password:
[STAYnnnn]
Value: nnnn - 4-digit user password
Example: STAY1111
2. After the system is successfully armed, it will reply with confirmation by SMS message to *User 1* phone number (by default).



For more details on how to disarm & turn off the alarm by EKB3 keyboard, please refer to chapter **3.2.5 Disarm & Turn off the Alarm by EKB2/EKB3 Keyboard**

3.4 Alarm Indications & Viewing Violated Zones / Tamper



By default configuration, the system makes a phone call to *User 1* in case of alarm. By answering the call, the user is able to listen on his/her mobile phone to what is happening in area surrounding ESIM264 unit. This feature is provided by a microphone (if any) connected to ESIM264.

The phone call is made to the next preset user (presumably to *User 2*) in a row in case the previous user was unreachable (was "out of radio coverage", provided "busy" signal or did not answer the call). This routine is continued until one of the preset users is reachable, but will not go in a circle i. e. return to *User 1* if none of the users were reachable. In addition, the system will not make a phone call to the next preset user in a row if the previous user was reachable, but rejected the phone call. The phone calls will cease to be made to the user as soon as the system is disarmed.



Fig. No. 22

NOTE: Your alarm system installer may have configured the system to make the phone calls to the next available user even if the previous one has answered the call.



By default configuration the system sends an SMS message containing violated zone or tamper number in case of alarm. The SMS message can also contain a star * character next to the violated tamper in case the tamper violation is caused due to wireless connection loss between ESIM264 and a wireless device (if any).

This SMS message is sent to *User 1*. The system sends the SMS message to the next preset user (presumably to User 2) in a row only if the previous user was unreachable (the system did not receive a successful SMS message delivery confirmation in 20 seconds from the recipient). This routine is continued until one of the preset users is reachable, but will not go in a circle i. e. return to *User 1* if none of the users were reachable. The SMS messages will cease to be sent to the user as soon as the system is disarmed.



Fig. No. 23

See also chapter **2.6 Viewing System Information.**

NOTE: Your alarm system installer may have configured the system to send the SMS message to the next available user even if the previous one has received it.

EKB2

The built-in EKB2 mini-buzzer and ESIM264 mini-buzzer (if any) provide short beeps continuously in case of alarm. In addition, the LCD screen back-light level is boosted and the alarm message (depending on violated zone type or tamper violation) is displayed in the main screen view of EKB2 screen. The mini-buzzer can be silenced by disarming the system using any method. Navigate through the following menu path using *OK* and arrow keys to view the violated zone or tamper number:

Menu path:

VIEW VIOLATED ZONE: **OK → VIOLATED ZONES → ZONE [1... 44]**

VIEW VIOLATED TAMPER: **OK → VIOLATED TAMPERS → TAMPER [1... 44]**

EKB3

The built-in EKB3 mini-buzzer and ESIM264 mini-buzzer (if any) provide short beeps continuously in case of alarm. In addition, the violated zone number is indicated by illuminated zone LED or flashing **SYSTEM** LED (if the violated zone number is above 12). The violated tamper number is indicated by illuminated **SYSTEM** LED. The mini-buzzer can be silenced by disarming the system using any method.

For more details on EKB3 violated high zone & tamper number indication, please, refer to chapter **3.10 Trouble Indications**.



By default configuration, the siren (if any) provides continuous alarm sound for 1 minute in case of alarm. The fire alarm is indicated by pulsing siren alarm sound. Siren alarm sound can be silenced by disarming the system using any method.

3.5 Bypassing & Unbypassing Violated Zone

Arming the system is disabled while there's at least 1 violated zone. Bypassing the zone allows to temporarily disable a particular violated zone and arm the alarm system after-wards.

EKB2

Navigate through the following path using *OK* and arrow keys to bypass a violated zone (-s):

Menu path:

Bypass a zone: **OK → BYPASS → BYPASS LIST [1... 3] → ZONE [1... 44] → BYPASS**

Bypass all zones: **OK → BYPASS → BYP VIOLATED ZONES**

Navigate through the following path using *OK* and arrow keys to unbypass a violated zone:

Menu path:

Unbypass a zone: **OK → BYPASS → BYPASS LIST [1... 3] → ZONE [1... 44] → UNBYPASS**

NOTE: The alternative way to unbypass all zones at once is to arm and disarm the system.

EKB3

Bypass a violated zone by entering the following combination using [BYP], number and [#] keys:

Enter zone number & user password:

[BYP]S_xxyyy#

Value: *xx* – zone number, range – [01... 44]; *yyyy* – 4-digit user password

Example: BYPS051111#

NOTE: The alternative way to unbypass all zones at once is to arm and disarm the system.

ATTENTION: Bypassing a violated tamper is NOT allowed. Please, restore the tamper (for example: close sensor's enclosure) before arming the system

3.6 Viewing System Information

SMS

1. In order to find out the system's current information, send the following SMS message to the system's phone number from any out of 5 preset user phone numbers:

SMS text:

`XXXX_INFO`

Example: 1111_INFO

2. The system will reply to the user phone number who sent the SMS message with the following up-to-date information:
 - system date & time;
 - system status (armed/disarmed);
 - GSM signal strength level;
 - main power supply status;
 - temperature of the area surrounding ESIM264 temperature sensor (if any);
 - state of zones (OK/alarm).

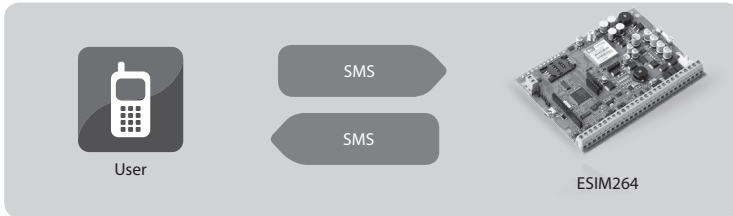

Fig. No. 24

3.7 Managing Periodical System Information

SMS

1. By default configuration, the SMS message mentioned in chapter 3.6 Viewing System Information is sent periodically to User 1 phone number at 11:00 daily.



Fig. No. 25

2. In order to set a different SMS sending frequency (in days) and time, send the following SMS message to the system's phone number from any out of 5 preset user phone numbers:

SMS text:

`XXXX_INFO:FF:TT`

Value: FF – frequency in days, range – [0... 125]; TT – time, range – [0... 23]

Example: 1111_INFO:2.15 (every 2nd day at 15:00)

3. In order to disable periodic SMS message, send the following SMS message to the system's phone number from any out of 5 preset user phone numbers:

SMS text:

`XXXX_INFO:0.0`

Example: 1111_INFO:0.0

4. The system will reply with confirmation by SMS message to the user phone number who sent the SMS message.

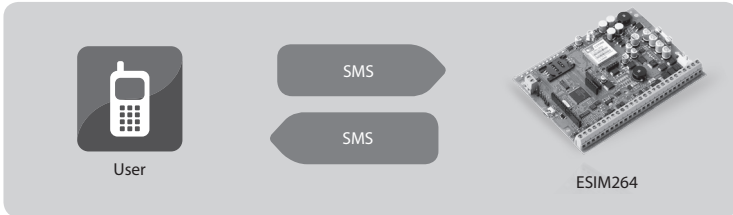

Fig. No. 26

3.8 Viewing Zone & PGM Output Information

SMS

1. In order to find out the current zone & PGM output information, send the following SMS message to the system's phone number from any out of 5 preset user phone numbers:

SMS text:

`XXXX_STATUS`

Example: 1111_STATUS

2. The system will reply to the user phone number who sent the SMS message with the following up-to-date information:
 - system status (armed/disarmed);
 - status of zones & PGM outputs (ON/OFF);
 - zone alarm texts;
 - PGM output names.

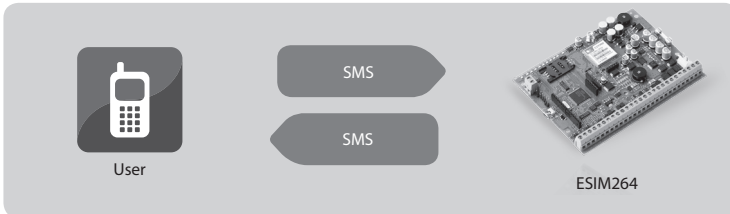

Fig. No. 27

3.9 Managing Temperature Information

SMS

1. If the temperature sensor is installed in your system, it can send an SMS message containing temperature value in case the set lowest or highest temperature limit value is exceeded. This SMS message is sent to *User 1* only. By default configuration this SMS message is disabled.



Fig. No. 28

2. In order enable or set a different lowest and highest temperature limit value, send the following SMS message to the system's phone number from any out of 5 preset user phone numbers:

SMS text:

`XXXX_TEMP:MIN:MAX`

Value: MIN - lowest temperature limit boundary in °C, range - [-55... 125];

MAX - highest temperature limit boundary in °C, range - [-55... 125]

Example: `1111_TEMP:-15:30`

3. In order to disable temperature SMS message, send the following SMS message to the system's phone number from any out of 5 preset user phone numbers:

SMS text:

`XXXX_TEMP:0:0`

Example: `1111_TEMP:0:0`

4. The system will reply with confirmation by SMS message to the user phone number who sent the SMS message.

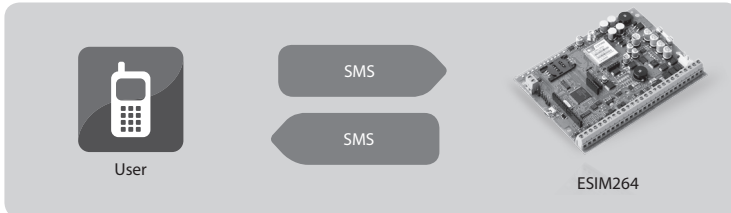

Fig. No. 29

3.10 Trouble Indications

EKB2

Message TBL displayed in the lower left side of the main screen view indicates presence of system troubles. In order to find out more on the particular system problem, please, open menu section TROUBLES. The description on each system problem is indicated in the table below.

Menu path:

OK → TROUBLES → T [1... 6]

Trouble	Name	Description
TROUBLE 1	VIOLATED TAMPER	One or more tampers are violated.
TROUBLE 2	REPLACE BATTERY	Backup battery problem.
TROUBLE 3	AC FAILURE	Main power supply problem.
TROUBLE 4	TIME NOT SET	Date/time not set.
TROUBLE 6	GSM ERROR	GSM connection problem.

EKB3

Yellow LED **SYSTEM** indicates system troubles. **SYSTEM** LED indications are mentioned in the table below.

SYSTEM LED	Description
Illuminated continuously	One ore more zones or tampers are violated; other system troubles
Flashing	One or more high zones are violated

In order to find out more on the particular system problem, please, enter command A. After this procedure the system will activate red zone LEDs for 15 seconds. The description on each LED indication is mentioned in the table below.

Zone LED	Description
1	One or more tampers are violated.
2	Backup battery problem.
3	Main power supply problem.
4	Date/time not set.
5	One or more high zones (Z13 - Z44) are violated.
6	GSM connection problem.

In order to find out which particular high zone is violated, please, enter command B.

In order to find out which particular tamper is violated, please, enter command C.

A. System trouble indication - enter command:

[CODE#]

B. Violated high zone indication – enter command:

[CODE1]

C. Violated tamper indication – enter command:

[CODE2]

The number of violated high zone or tamper can be calculated using the table below according to the formula: number from zone LED section B + number from zone LED section A.

Example: LED #3 from section A is flashing and LED #8 from section B is illuminated continuously. According to the table below LED #8 is equal to number 18, therefore 18 + 3 = 21.

Result: Violated high zone or tamper number is 21.

Zone LED section - A (flashing)	Zone LED section - B (illuminated continuously)
Zone LED 1 = 1	Zone LED 7 = 12
Zone LED 2 = 2	Zone LED 8 = 18
Zone LED 3 = 3	Zone LED 9 = 24
Zone LED 4 = 4	Zone LED 10 = 30
Zone LED 5 = 5	Zone LED 11 = 36
Zone LED 6 = 6	Zone LED 12 = 42

3.11 Controlling Electrical Appliances



Your system features 4 or more PGM outputs intended for connection and control of various electrical appliances. This provides a possibility to control garage gates, turn on and off your house heating, lighting, cooling system, reset smoke sensors to restored state etc. The PGM outputs must be configured by your installer before using them.

1. In order to turn ON a specified PGM output, send the following SMS message to the system's phone number from any out of 5 preset user phone numbers:

SMS text:

XXXX_Cn:ON or **XXXX_OutputName:ON**

Value: Cn – PGM output number, range – [C1... C44]

Example: 1111_Pump:ON

2. In order to turn OFF a specified PGM output, send the following SMS message to the system's phone number from any out of 5 preset user phone numbers:

SMS text:

XXXX_Cn:OFF or **XXXX_OutputName:OFF**

Value: Cn – PGM output number, range – [C1... C44]

Example: 1111_C2:OFF

3. The system will reply with confirmation by SMS message to the user phone number who sent the SMS message.



Fig. No. 30

3.12 Turning ON/OFF the Electrical Appliances for a Determined Time Period

1. In order to instantly turn ON a specified PGM output and keep it in this state for a determined time period, send the following SMS message to the system's phone number from any out of 5 preset user phone numbers:

SMS text message content:

`XXXX_Cn:ON:hr.mn:sc` or `XXXX_OutputName:ON:hr.mn:sc`

Value: Cn – PGM output number, range – [C1... C44]; hr – hours, range – [00... 23], mn – minutes, range – [00... 59]; sc – seconds, range – [00... 59].

Example: `1111_Pump:ON:12:30:15`

2. In order to instantly turn OFF a specified PGM output and keep it in this state for a determined time period, send the following SMS message to the system's phone number from any out of 10 preset user phone numbers:

SMS text message content:

`XXXX_Cn:OFF:hr.mn:sc` or `XXXX_OutputName:OFF:hr.mn:sc`

Value: Cn – PGM output number, range – [C1... C44]; hr – hours, range – [00... 23], mn – minutes, range – [00... 59]; sc – seconds, range – [00... 59].

Example: `1111_C3:OFF:13.25:56`

3. The system will reply with confirmation by SMS text message to the user phone number who sent the SMS message.

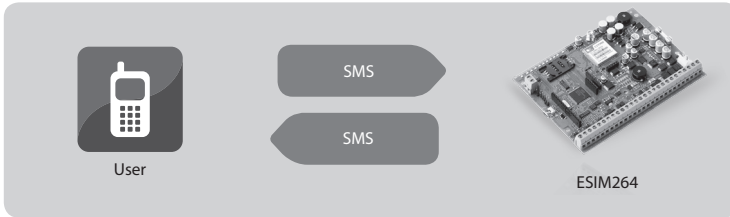

Fig. No. 31

4. If the Alarm System is Connected to Monitoring Station

The following system features become disabled automatically or may be disabled by your alarm system installer if the system is connected to a monitoring station:

- Confirmation by SMS message when arming, disarming & turning off the alarm by phone call, SMS message, EKB2/EKB3 keyboard, iButton® key, EWK1 - wireless key-fob;
- Alarm indication by phone call;
- Alarm indication by SMS message;
- Violated zone/tamper name indication by SMS message;
- Temperature indication by SMS message;
- Periodical system information by SMS message;
- Main power loss/restore indication by SMS message.

NOTE: For full system configuration and control, please refer to ESIM264 installation manual located at www.eldes.it/en/download

